

General Specifications

Electrical Capacity (Resistive Load)

Power Level: 3A @ 250V AC

Other Ratings

Contact Resistance: 20 milliohms maximum
Insulation Resistance: 1,000 megohms minimum @ 500V DC
Dielectric Strength: 1,000V AC minimum between contacts for 1 minute minimum;
 1,500V AC minimum between contacts & case for 1 minute minimum
Mechanical Life: 30,000 cycles minimum
Electrical Life: 10,000 cycles minimum
Static Capability: Withstands 15 kilovolts minimum ESD minimum (for CKM models only)
Nominal Operating Torque: 16mm Bushing (CKM models):
 .04 mNm (5.67 oz•in) for Flat Key
 .08 mNm (11.33 oz•in) for Tubular Key
 19mm Bushing (CKL models):
 .05 mNm (7.08 oz•in) for Flat Key
 .07 mNm (9.91 oz•in) for Tubular Key
Contact Timing: Break-before-make
Angle of Throw: 90° for 2-position & 45° for 3-position

Materials & Finishes

Keys for CKM: Brass with nickel plating with ABS handle
Keys for CKL: Brass with nickel plating for tubular key;
 brass with chrome plating for flat key
Housing/Bushing: Glass fiber reinforced PBT for CKM models;
 zinc alloy with chrome plating for CKL
Base: LCP (Liquid Crystal Polymer)
Contact Terminals: Copper with silver plating
Common Terminals: Copper with silver plating
Movable Contactor: Copper
Movable Contacts: Silver

Environmental Data

Operating Temperature Range: -25°C through +70°C (-13°F through +158°F)
Humidity: 90 ~ 95% humidity for 240 hours @ 40°C (104°F) for CKM;
 90 ~ 95% humidity for 96 hours @ 40°C (104°F) for CKL
Vibration: 10 ~ 55Hz with peak-to-peak amplitude of 1.5mm for CKM or 0.7mm for CKL traversing the
 frequency range & returning in 1 minute; 3 right angled directions for 2 hours
Shock: 50G (490m/s²) acceleration for CKM; 30G (294m/s²) acceleration for CKL; (CKM & CKL tested
 in 6 right angled directions, with 5 shocks in each direction)

Installation

Mounting Torque: 1.5 Nm (13.28 lb•in) maximum
Soldering Time & Temperature: Manual Soldering: See Profile A in Supplement section.

Toggle

Rockers

Pushbuttons

Illuminated PB

Programmable

F
Keylocks

Rotaries

Slides

Tactiles

Tilt

Touch

Indicators

Accessories

Supplement

Distinctive Characteristics

High insulating material for 16mm CKM models withstands over 15 kilovolts of electrostatic discharge, thus providing antistatic feature.

Rugged, die cast housing 19mm CKL models designed for higher security requirements.

Vertically rotating switching mechanism combines with self-cleaning sliding contacts for high reliability and long operating life.

16mm and 19mm diameter bushings available.

CKL and CKM on-off-on models with tubular keys have push-and-lock mechanism which allows contactor to drop and slide over stationary contacts.

Available in both flat and tubular key styles; flat key is reversible for easier setting.

Epoxy sealed terminals prevent entry of flux and other contaminants.

Interior construction provides seal for contact area.

High dielectric strength of 1,500 volts between contacts and case.

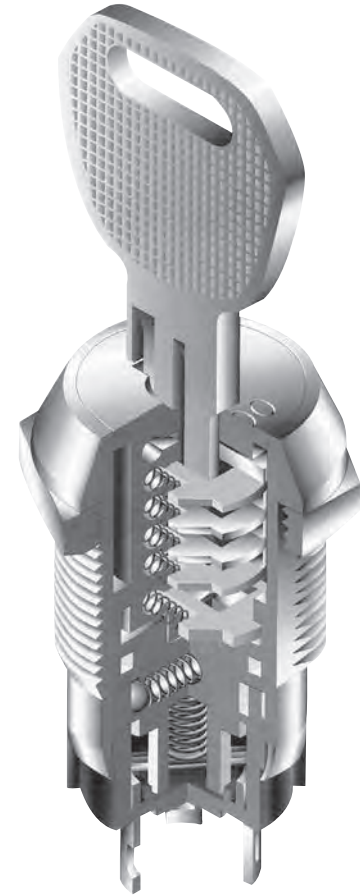

Actual Size CKM with Tubular Key

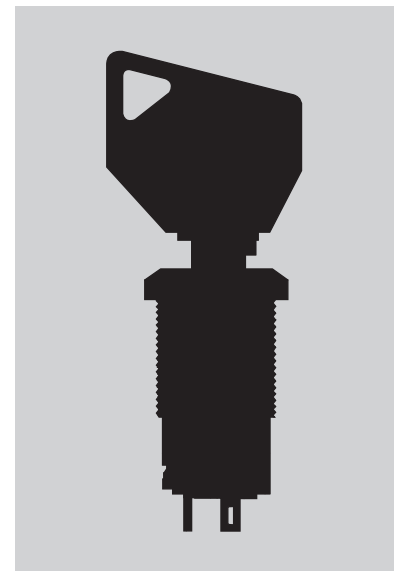

Toggles

Rockers

Pushbuttons

Illuminated PB

Programmable

Keylocks

Rotaries

Slides

Tactiles

Tilt

Touch

Indicators

Accessories

Supplement

TYPICAL SWITCH ORDERING EXAMPLE

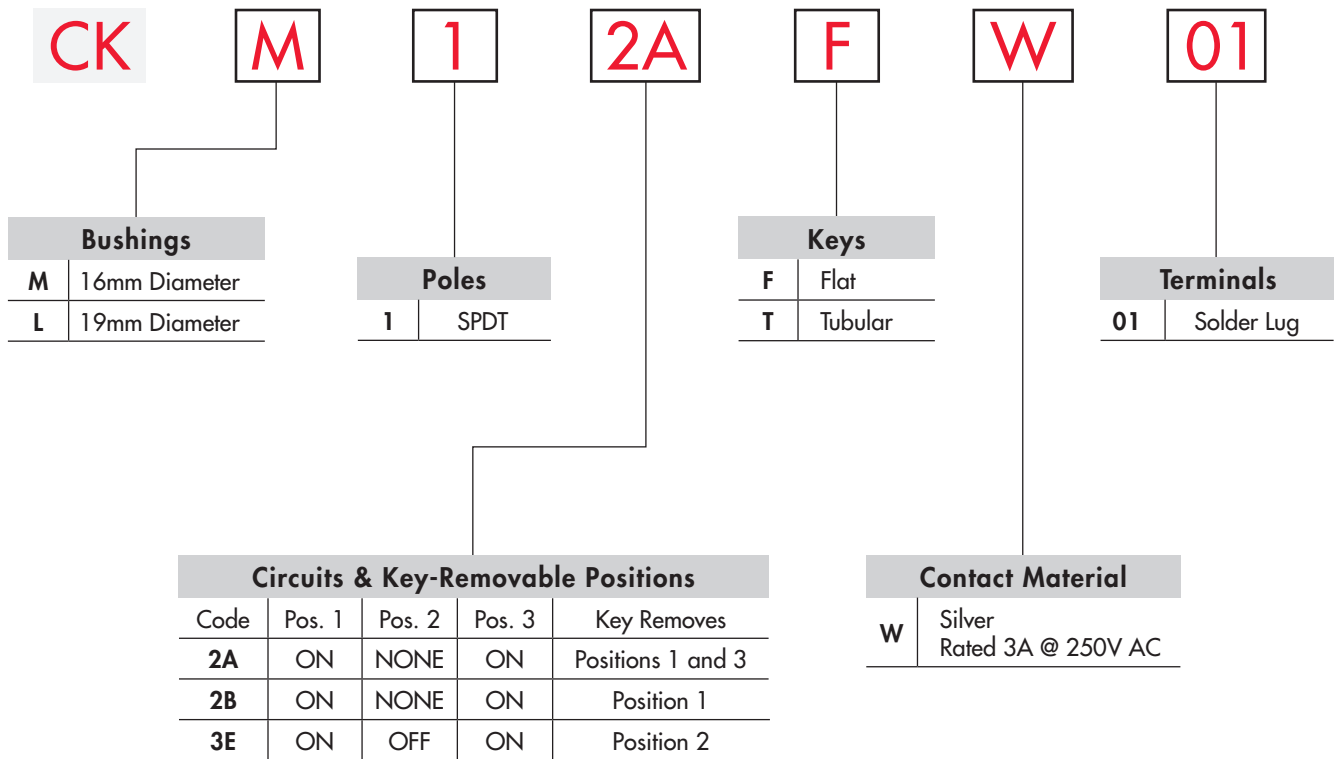

DESCRIPTION FOR TYPICAL ORDERING EXAMPLE

CKM12AFW01

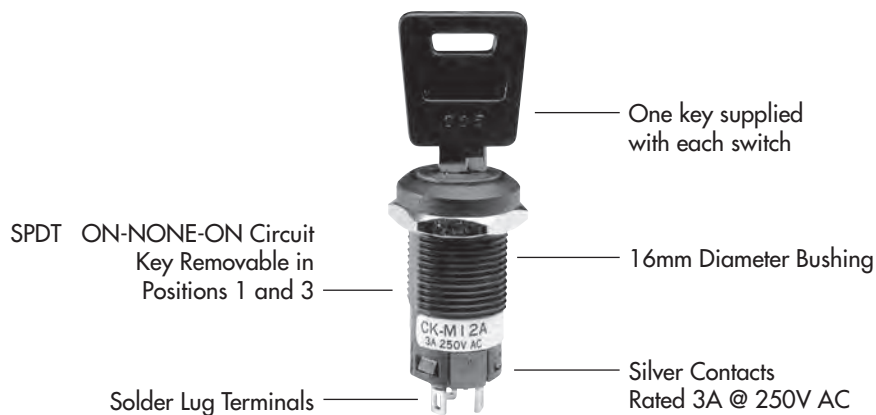

POLES, CIRCUITS & KEY-REMOVABLE POSITIONS

Pole & Throw	Model	Key Positions			Connected Terminals (Terminal numbers are on switch)			Schematic	⊙ = Key Removable ● = Not Removable ✓ = Maximum Arc
		Pos 1	Pos 2	Pos 3	Pos 1	Pos 2	Pos 3		
SPDT	CKM12A CKL12A	ON	NONE	ON	COM-1	—	COM-2		
SPDT	CKM12B CKL12B	ON	NONE	ON	COM-1	—	COM-2		
SPDT	CKM13E CKL13E	ON	OFF	ON	COM-1	OPEN	COM-2		

KEYS

F Flat Key

- AT4147 for CKM 16mm**
Brass with Nickel Plating key base & ABS key handle
- AT4153 for CKL 19mm**
Brass with Chrome Plating (crosshatch texture on handle)

One key provided with each switch (no master key available)
For ordering additional keys, indicate the same key number that is engraved on the face of your switch.

Randomly assigned key number (001 through 010 for CKM models & 001 through 025 for CKL models).

Typical Key Ordering Example: AT4153-001

T Tubular Key (must be pressed inward to actuate)

- AT4146 for CKM 16mm**
Brass with Nickel Plating key base & ABS key handle
- AT4152 for CKL 19mm**
Brass with Nickel Plating (smooth)

One key provided with each switch (no master key available)
For ordering additional keys, indicate the same key number that is engraved on the face of your switch.

Randomly assigned key number (001 through 025 for CKM models & 001 through 050 for CKL models).

Typical Key Ordering Example: AT4146-001

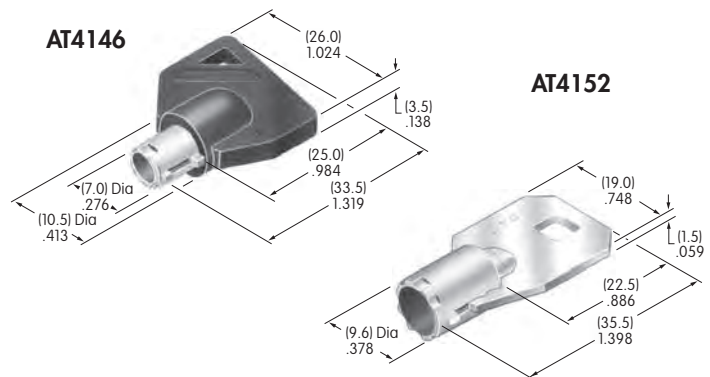
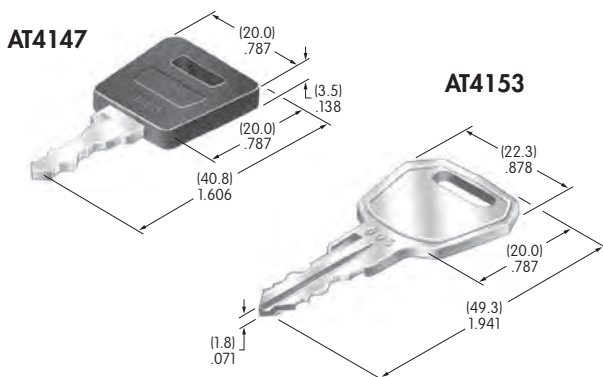

CONTACT MATERIALS, RATINGS & TERMINALS

W Silver over Silver
Power Level 3A @ 250V AC

01 Solder Lug Terminals

Solder Lug Terminal for CKM

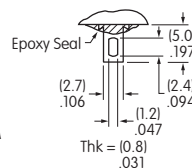

Solder Lug Terminal for CKL

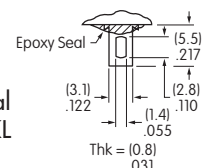

Toggles
Rockers
Pushbuttons
Illuminated PB
Programmable
Keylocks
Rotaries
Slides
Tactiles
Tilt
Touch
Indicators
Accessories
Supplement

TYPICAL SWITCH DIMENSIONS

90°
Angular
Throw

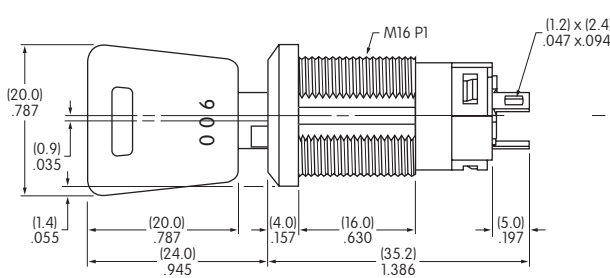
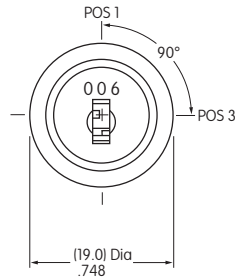

16mm Bushing • Flat Key

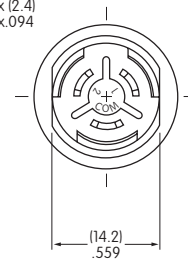

CKM12AFW01

45°
Angular
Throw

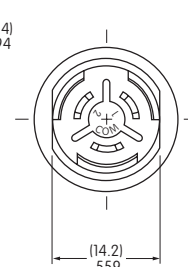
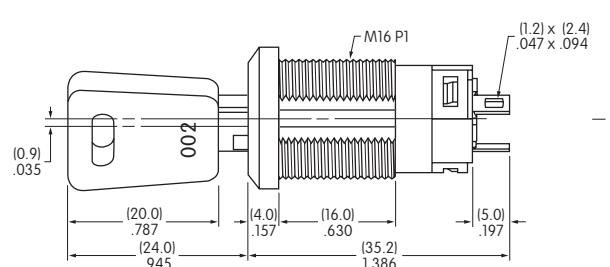
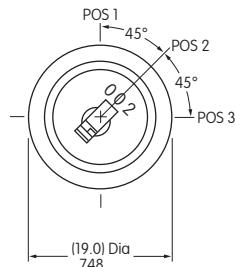

Toggles
Rockers
Pushbuttons
Illuminated PB
Programmable
F Keylocks

90°
Angular
Throw

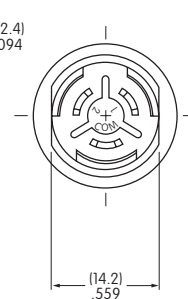
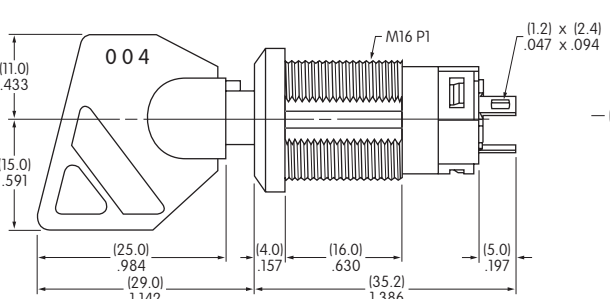
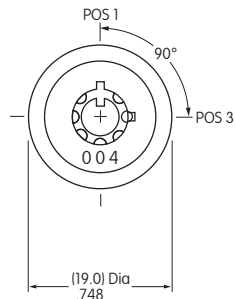

CKM13ETW01

45°
Angular
Throw

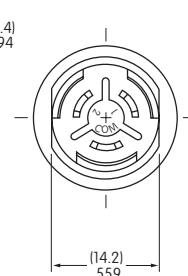
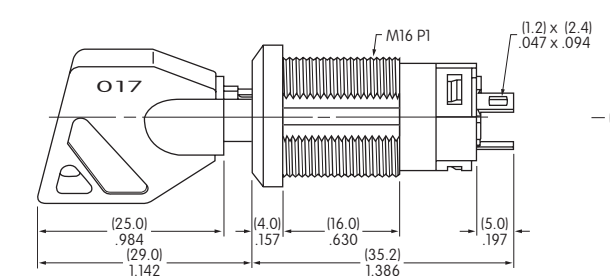
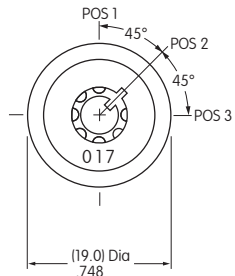

Rotaries
Slides
Tactiles
Tilt
Touch

PANEL CUTOUT & STANDARD HARDWARE FOR 16MM BUSHING

Maximum Effective
Panel Thickness:
.469" (11.9mm)

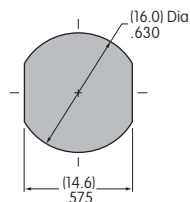

AT016
16mm Hex Mounting Nut
for CKM

1 included with each switch
Steel with nickel plating

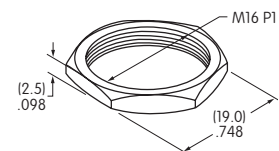

Indicators
Accessories
Supplement

TYPICAL SWITCH DIMENSIONS

19mm Bushing • Flat Key



**90°
Angular
Throw**

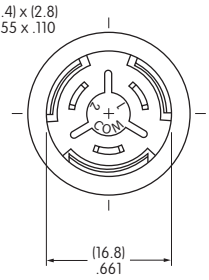
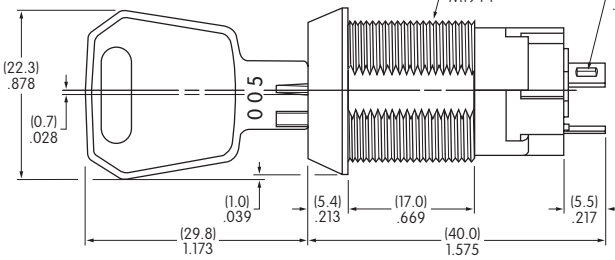
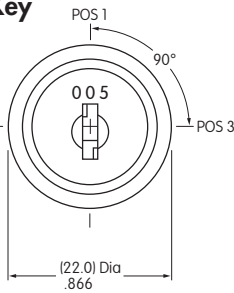

**45°
Angular
Throw**

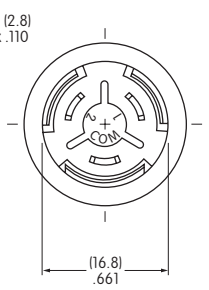
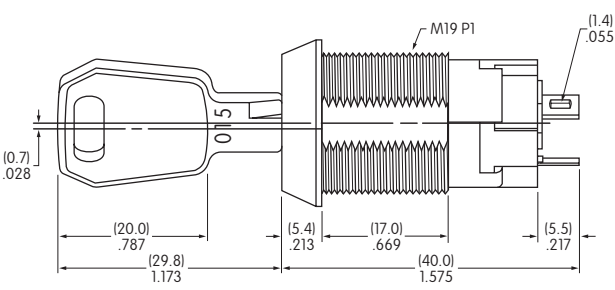
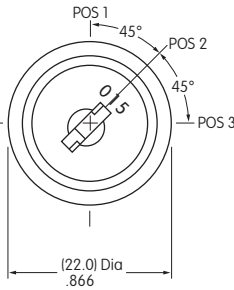

CKL12AFW01

19mm Bushing • Tubular Key



**90°
Angular
Throw**

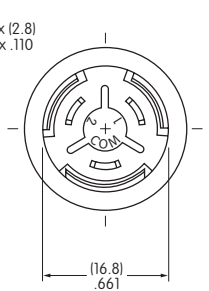
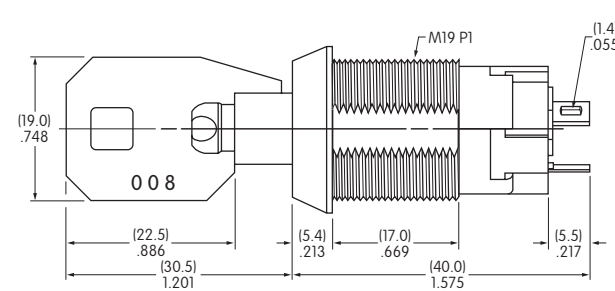
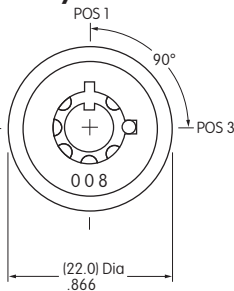

**45°
Angular
Throw**

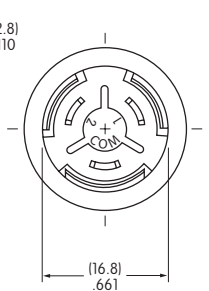
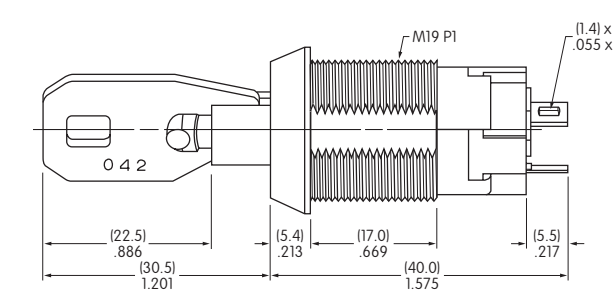
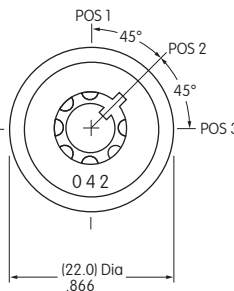

CKL13ETW01

PANEL CUTOUT & STANDARD HARDWARE FOR 19MM BUSHING

Maximum Effective
Panel Thickness:
.496" (12.6mm)

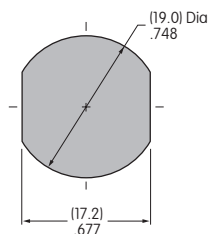

**AT019
19mm Hex Mounting Nut
for CKL**

1 included with each switch
Steel with nickel plating

