

General Specifications

Toggles

Rockers
B

Pushbuttons

Illuminated PB

Programmable

Keylocks

Rotaries

Slides

Tactiles

Tilt

Touch

Indicators

Accessories

Supplement

Electrical Capacity (Resistive Load)

Logic Level: 0.4VA maximum @ 28V AC/DC maximum
(Applicable Range 0.1 mA ~ 0.1 A @ 20mV ~ 28V)
Note: Find additional explanation of operating range in Supplement section.

Other Ratings

Contact Resistance: 80 milliohms maximum
Insulation Resistance: 500 megohms minimum @ 500V DC
Dielectric Strength: 500V AC minimum for 1 minute minimum
Mechanical Life: 50,000 operations minimum
Electrical Life: 50,000 operations minimum
Nominal Operating Force: For Rockers 1.70N; for Paddles 1.30N
Angle of Throw: 28°

Materials & Finishes

Actuator: Glass fiber reinforced polyamide (UL94V-0)
Case: Glass fiber reinforced polyamide (UL94V-0)
Sealing Ring: Nitrile butadiene rubber
Movable Contact: Phosphor bronze with gold plating
Stationary Contacts: Phosphor bronze with gold plating
Base: Glass fiber reinforced polyamide (UL94V-0)
Mounting Bracket: Phosphor bronze with tin plating
Terminals: Phosphor bronze with gold plating

Environmental Data

Operating Temperature Range: -30°C through +85°C (-22°F through +185°F)
Humidity: 90 ~ 95% humidity for 240 hours @ 40°C (104°F)
Vibration: 10 ~ 55Hz with peak-to-peak amplitude of 1.5mm traversing the frequency range & returning in 1 minute; 3 right angled directions for 2 hours
Shock: 50G (490m/s²) acceleration (tested in 6 right angled directions, with 5 shocks in each direction)

PCB Processing

Soldering: Wave Soldering Recommended: See Profile A in Supplement section.
Manual Soldering: See Profile A in Supplement section..
Cleaning: These devices are not process sealed. Hand clean locally using alcohol based solution.

Standards & Certifications

Flammability Standards: UL94V-0 actuator & case/base

The GW Series rockers have not been tested for UL recognition or CSA certification. These switches are designed for use in a low-voltage, low-current, logic-level circuit. When used as intended in a logic-level circuit, the results do not produce hazardous energy.

Distinctive Characteristics

Various colored rockers and paddles.

Combination of dust cover and closely fit housing, actuator, and interior pivot provides protection for contacts.

Detent mechanism design of coil spring, plunger, and plastic detent results in crisp and positive actuation.

Extremely thin size allows high density PCB mounting and makes these switches ideal for handheld equipment.

Award-winning STC contact mechanism with benefits unavailable in conventional mechanisms: smoother, positive detent actuation, increased contact stability and unparalleled logic-level reliability. (Additional STC details in Terms & Acronyms; see Supplement section.)

Molded-in, epoxy sealed terminals lock out flux and other contaminants.

.100" x .100" (2.54mm x 2.54mm) terminal spacing conforms to standard PC board grid spacing for straight and angle mounting.



Actual Size

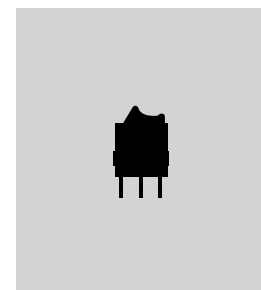

TYPICAL SWITCH ORDERING EXAMPLE

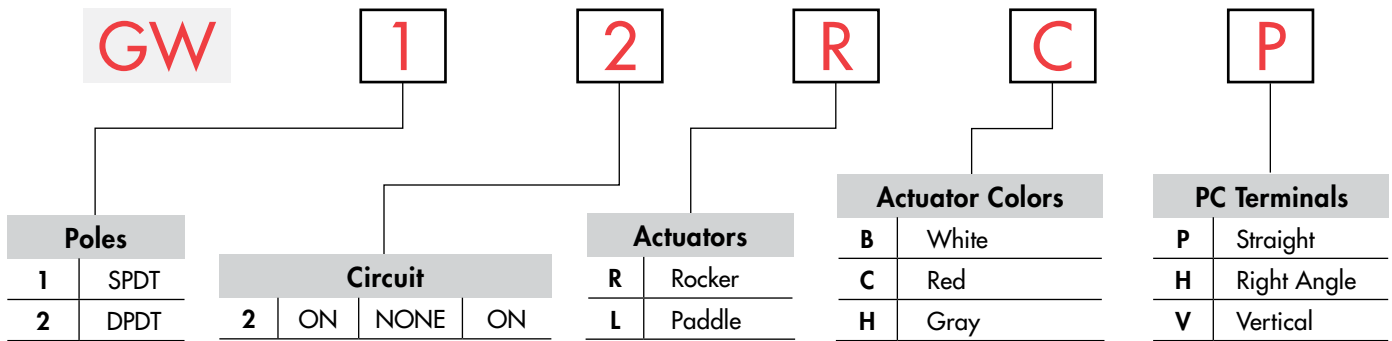

DESCRIPTION FOR TYPICAL ROCKER ORDERING EXAMPLE

GW12RCP

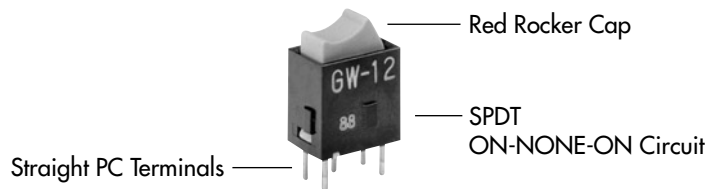

POLES & CIRCUIT

Pole	Model	Rocker Position			Connected Terminals			Throw & Schematics
		Up	Center	Down	Up	Center	Down	
SP	GW12	ON	NONE	ON	5-6	OPEN	5-4	SPDT Note: Terminal numbers are not actually on the switch.
DP	GW22	ON	NONE	ON	5-6 2-3	OPEN	5-4 2-1	DPDT

TYPICAL SWITCH DIMENSIONS

Straight PC



GW12RCP

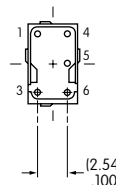
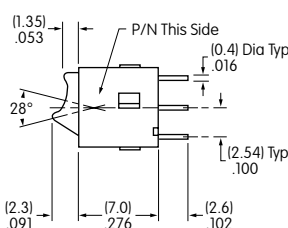
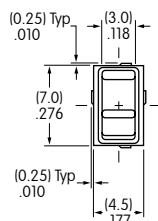

Single Pole

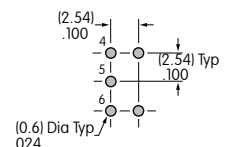

On single pole models positions 1 & 3 are support pins.

Straight PC



GW22LCP

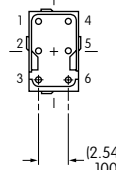
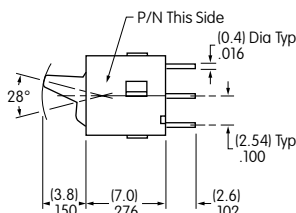
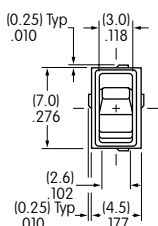

Double Pole

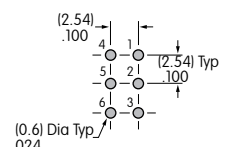

TYPICAL SWITCH DIMENSIONS

Single Pole

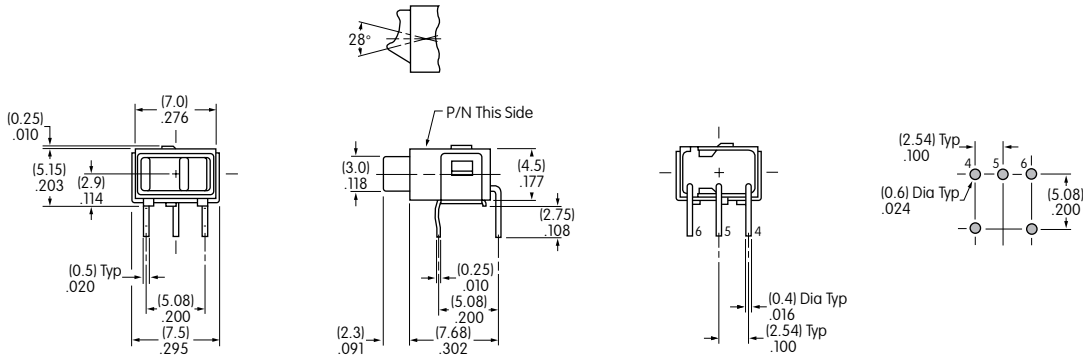

GW12RCH

Right Angle PC



Double Pole

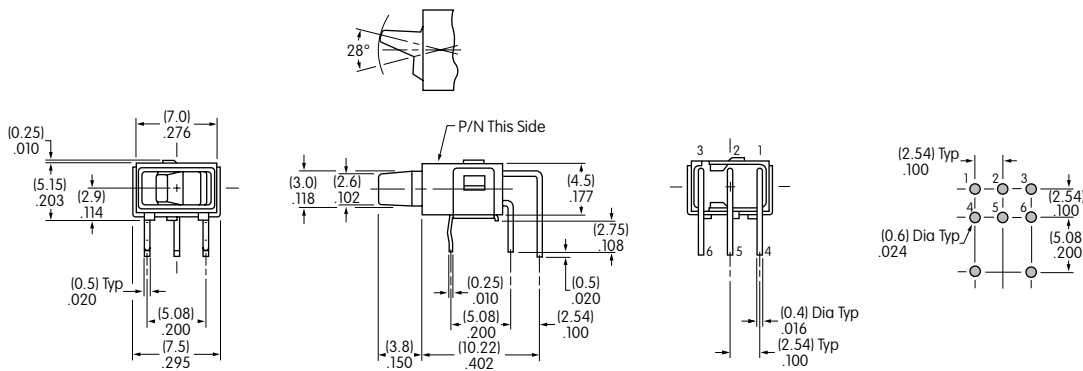

GW22LCH

Right Angle PC



Single Pole

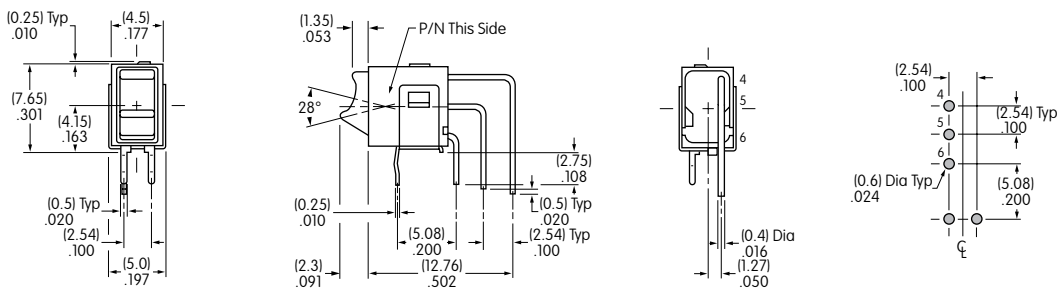

GW12RCV

Vertical PC

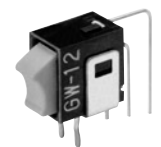

Double Pole

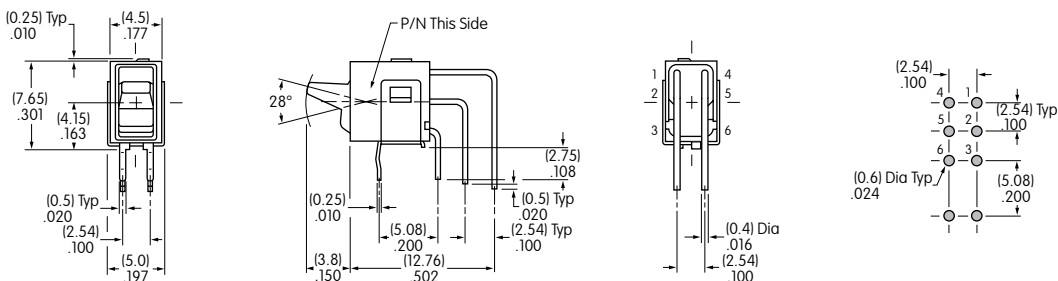

GW22LCV

Vertical PC

