

NEW PRODUCTS

Contact No.148

YB2 Pushbuttons

Flush Button With Panel Seal
Only 1.8mm Above Panel
Super Bright Illumination

Available September 1, 2008

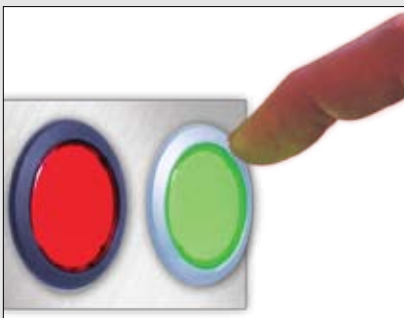

General Specifications

Electrical Capacity (Resistive Load)

Power Level (silver):	3A @ 125V AC or 3A @ 250V AC or 3A @ 30V DC
Logic Level (gold):	0.4VA maximum @ 28V AC/DC maximum (Applicable Range 0.1mA ~ 0.1A @ 20mV ~ 28V)

Other Ratings

Contact Resistance:	50 milliohms maximum for silver; 100 milliohms maximum for gold
Insulation Resistance:	200 megohms minimum @ 500V DC
Dielectric Strength:	1,000V AC minimum between contacts for 1 minute minimum; 1,500V AC minimum between contacts & case for 1 minute minimum
Mechanical Life:	1,000,000 operations minimum for momentary circuit 200,000 operations minimum for maintained circuit
Electrical Life:	100,000 operations minimum
Nominal Operating Force:	Single pole: 1.5N Double pole: 3.0N
Contact Timing:	Nonshorting (break-before-make)
Travel:	Pretravel .059" (1.5mm); Overtravel .059" (1.5mm); Total Travel .118" (3.0mm)

Materials & Finishes

Bezel:	Black: Glass fiber reinforced polyamide (UL94V-0); Silver: Polycarbonate (UL94V-2)
Housing:	Glass fiber reinforced polyamide (UL94V-0)
Base:	Diallyl phthalate resin (UL94V-0)
Movable Contactor:	Phosphor bronze with silver or gold plating
Movable Contacts:	Silver alloy with silver plating or brass with gold plating
Stationary Contacts:	Silver alloy or copper with gold plating
Switch Terminals:	Phosphor bronze with tin plating
Lamp Terminals:	Phosphor bronze with tin plating

Environmental Data

Operating Temp Range:	-25°C through +50°C (-13°F through +122°F) for illuminated models; -25°C through +70°C (-13°F through +158°F) for nonilluminated models
Humidity:	90 ~ 95% humidity for 96 hours @ 40°C (104°F)
Vibration:	10 ~ 55Hz with peak-to-peak amplitude of 1.5mm traversing the frequency range & returning in 1 minute; 3 right angled directions for 2 hours
Shock:	50G (490m/s ²) acceleration (tested in 6 right angled directions, with 5 shocks in each direction)
Sealing:	IP65 of IEC60529 standard

Installation

Mounting Torque:	0.785Nm (6.95 lb·in) maximum
Quick Connect Force:	24.5N maximum downward force on connector
Soldering Time & Temperature:	Manual Soldering: 390°C maximum for 4 minutes maximum

Standards & Certifications

Flammability Standards:	UL94V-0 housing & base
UL & C-UL Recognized:	All solder lug models recognized at 3A @ 125/250V AC or 0.4VA @ 28V AC/DC maximum; UL File No. WOYR2.E44145; add "/U" to end of part number to order UL mark on switch; UL File No. WOYR8.E44145; add "/C-UL" to end of part number to order C-UL mark on switch.

Distinctive Characteristics

Shortest above-panel dimension (1.8mm) in the industry for splashproof design.

Choice of cap colors include clear, red, green, amber, or metallic silver for enhanced panel design.
(Metallic silver is for non-illuminated only.)

Bright full face LED illumination in choice of red, green, or amber with white diffuser and super bright in blue, green, or white with white diffuser.

Bezel color silver or black.

Tamperproof 19mm diameter actuator.

Short body of .965" (24.5mm) conserves behind-panel space.

Available in momentary and alternate action with latchdown.

Crisp actuation and clear circuit status provided by snap-action contact mechanism. Arc barrier protects against crossover.

Dusttight and splashproof panel seal to IP65 of IEC60529 standards (similar to NEMA 4 and 13).

Distinctive long stroke and light touch actuation for clear indication of circuit status.

Combination solder lug and .110" quick connect terminals. Terminals are epoxy sealed to lock out flux, dust, solvents, and other contaminants, as well as to secure terminals and improve contact stability.

Custom legends on actuator available.

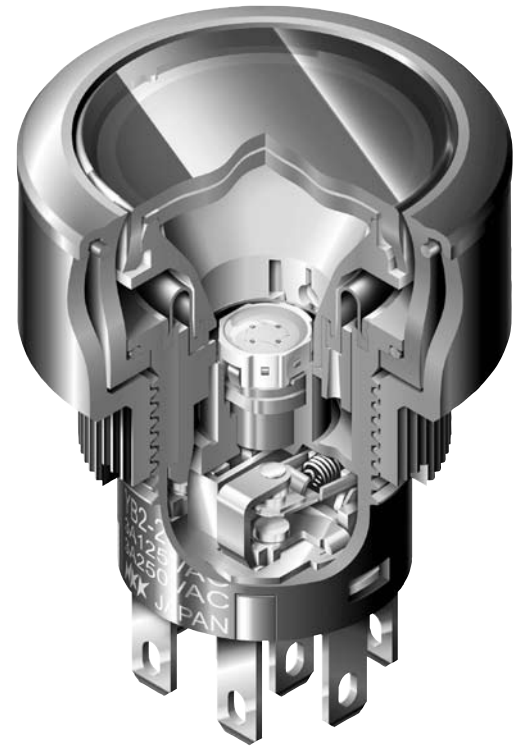

Actual Size

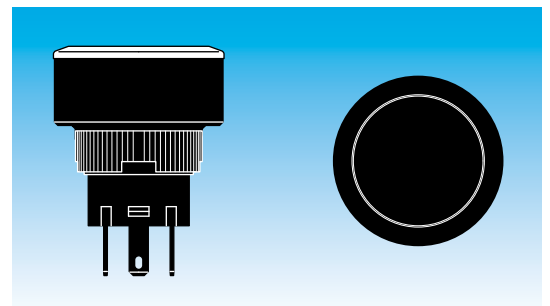

TYPICAL SWITCH

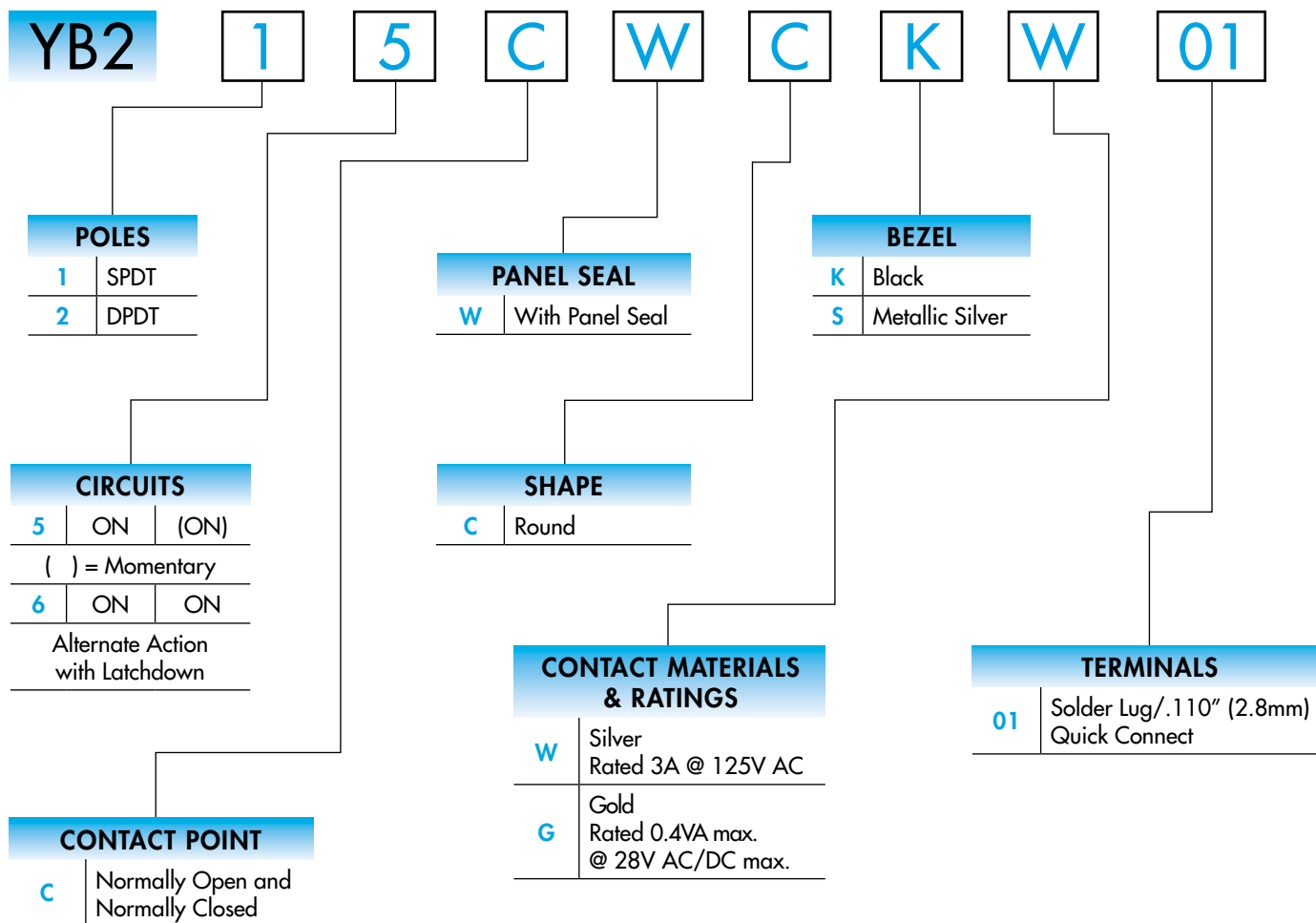

DESCRIPTION FOR TYPICAL ORDERING EXAMPLE

YB215CWCKW01-6F-JB



ORDERING EXAMPLE

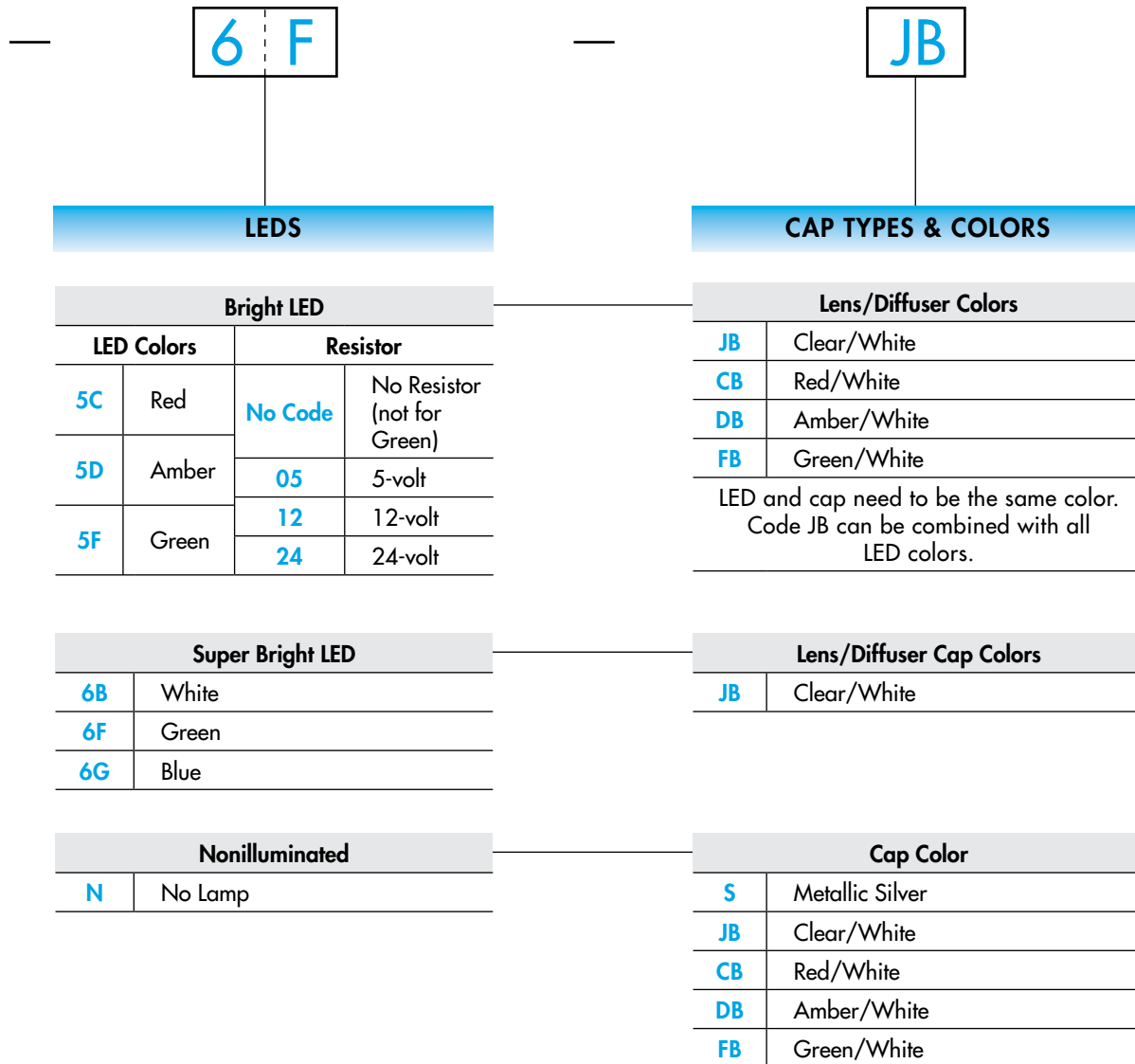

IMPORTANT:



Switches are supplied without UL, C-UL, & CSA markings unless specified. Specific models & ratings noted on General Specifications page.

POLES & CIRCUITS

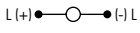
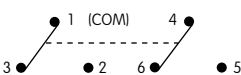
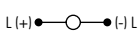
Pole	Model	Plunger Position () = Momentary		Connected Terminals		Throw & Switch/Lamp Schematics
		Normal	Down	Normal	Down	
SP	YB215 YB216	ON ON	(ON) ON	1-3	1-2	Notes: Switch is marked with NC, NO, COM, L+, L-. Lamp circuit is isolated and requires external power source.  
DP	YB225 YB226	ON ON	(ON) ON	1-3 4-6	1-2 4-5	 

CONTACT POINT

C Normally Open and Normally Closed

PANEL SEAL

W Panel Seal

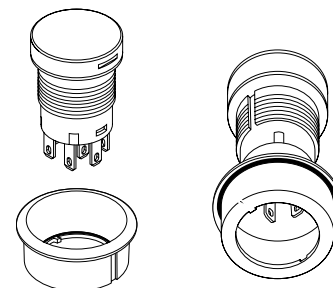

SHAPE

C Round

BEZEL

K Black

S Silver

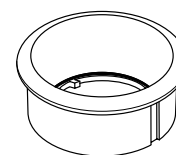

CONTACT MATERIALS & RATINGS

W Silver Contacts

Power Level

3A @ 125/250V AC

G Gold Contacts

Logic Level

0.4VA max. @ 28V AC/DC max.

TERMINALS

01 Solder Lug/
.110" (2.8mm) Quick Connect

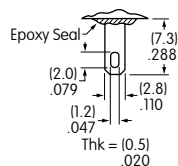

BRIGHT & SUPERBRIGHT LEDs

The electrical specifications shown are determined at a basic temperature of 25°C. LED circuit is isolated and requires external power source. If the source voltage exceeds the rated voltage, a ballast resistor is required.

Base of AT634 and AT636 is Black for 5V, Light Blue for 12V and Gray for 24V.

Electrical Specifications for Bright LED without Resistor

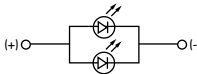
Bright AT628  T-1 Bi-pin 	Colors Available: 5C Red 5D Amber No Code No Resistor	Unit			
	LED Colors	Red	Amber		
	Forward Peak Current	I_{FM}	40	40	mA
	Continuous Forward Current	I_F	26	26	mA
	Forward Voltage	V_F	1.9	2.0	V
	Reverse Peak Voltage	V_{RM}	4	4	V
	Current Reduction Rate Above 25°C	ΔI_F	0.50		mA/°C
	Ambient Temperature Range	-25 ~ +50		°C	

Electrical Specifications for Bright Red and Amber LED with Resistor

Bright AT634  T-1 ¼ Bi-pin	Colors Available: 5C Red 5D Amber 05 12 24	Unit				
	Forward Peak Current	I_{FM}	—	—	—	mA
	Continuous Forward Current	I_F	25	20	10	mA
	Forward Voltage	V_F	5	12	24	V
	Reverse Peak Voltage	V_{RM}	4	8	16	V
	Current Reduction Rate Above 25°C	ΔI_F	—	—	—	mA/°C
Ambient Temperature Range	-25 ~ +50		°C			

AT634
5-volt,
2-element
with Resistor

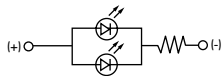



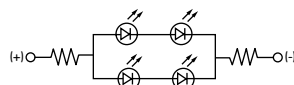

AT634
12-volt,
4-element
with Resistor

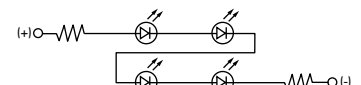



AT634
24-volt,
4-element
with Resistor

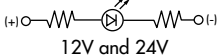

Electrical Specifications for Bright Green LED with Resistor

Bright AT636  T-1 ¼ Bi-pin  5V  12V and 24V	Colors Available:  5F Green 05 12 24	Unit				
	Forward Peak Current	I_{FM}	—	—	—	mA
	Continuous Forward Current	I_F	11	9.5	8.7	mA
	Forward Voltage	V_F	5	12	24	V
	Reverse Peak Voltage	V_{RM}	5	5	5	V
	Current Reduction Rate Above 25°C	ΔI_F	—	—	—	mA/°C
Ambient Temperature Range	-25 ~ +50		°C			

Electrical Specifications for Super Bright LED

Super Bright AT625G Blue AT631B White AT632F Green  T-1 Bi-pin	 	Colors: 6B White 6F Green 6G Blue	Unit			
	Forward Peak Current	I_{FM}	30	30	30	mA
	Continuous Forward Current	I_F	20	20	20	mA
	Forward Voltage	V_F	3.6	3.5	3.6	V
	Reverse Peak Voltage	V_{RM}	5	5	5	V
	Current Reduction Rate Above 25°C	ΔI_F	0.50		mA/°C	
	Ambient Temperature Range	-25 ~ +50		°C		

BALLAST RESISTOR CALCULATION FOR LEDS

If the source voltage is greater than the rated voltage of a lamp or LED, a ballast resistor must be connected in series with the lamp. The following circuit diagram and formula will assist in calculating the value of the required ballast resistor.

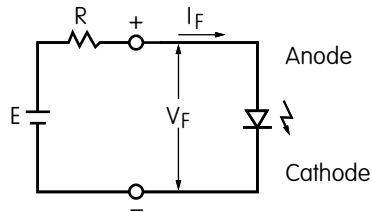

$$R = \frac{E - V_F}{I_F}$$

Where: R = Resistor Value (Ohms)
 E = Source Voltage (V)
 V_F = Forward Voltage (V)
 I_F = Forward Current (A)

CAPS & CAP COLORS

AT3017 Cap for Bright LEDS

Lens/Insert
 Colors Available:

- CB** Red/White
- DB** Amber/White
- FB** Green/White

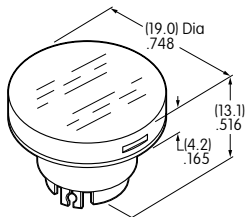

AT3018 Cap for Super Bright LEDS

Lens/Insert
 Colors Available:

- JB** Clear/White

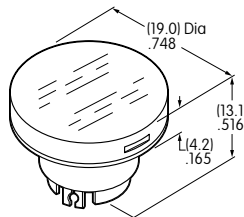

AT3019 Cap for Nonilluminated

Cap Color
 Available:

- S** Metallic Silver

Note: AT3017 and AT3018 can also be used without illumination.

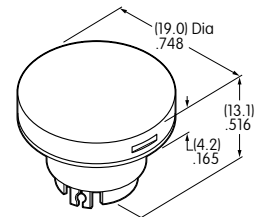

Material: Polycarbonate (Lens & Insert)

TYPICAL SWITCH DIMENSIONS

Round • Panel Seal

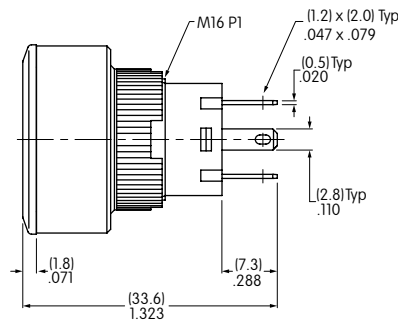
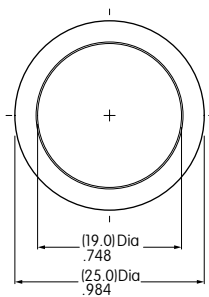

Single Pole

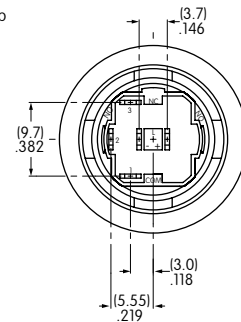

Double Pole

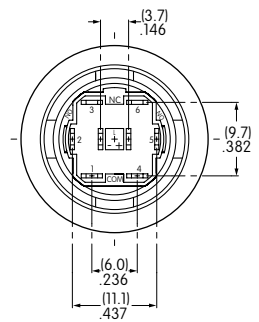

YB215CWCKW01-6F-JB

PANEL THICKNESS & CUTOUT

Panel Thickness
 .020" ~ .197"
 (0.5mm ~ 5.0mm)

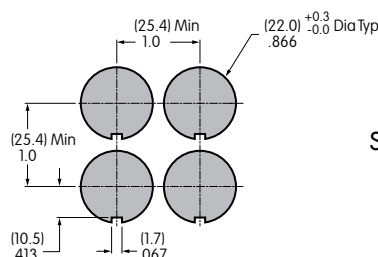

Side-by-side Mounting

ASSEMBLY INSTRUCTIONS

1. Remove mounting nut.

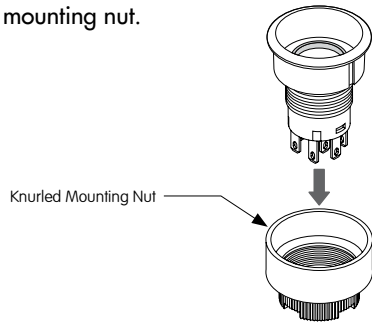

2. Remove flange and red o-ring from housing. There are two o-rings in this assembly: one is red, one is orange.

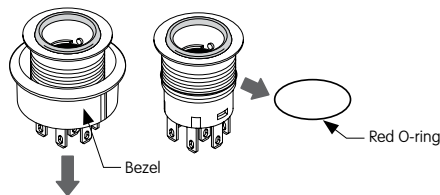

3. Install LED.

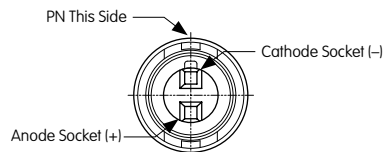

AT634, AT636

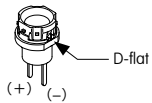

Align D-flat on LED with PN on switch for appropriate polarity and insert LED into base.



AT628

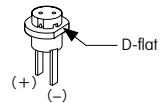

Align D-flat on LED with PN on switch for appropriate polarity and insert LED into base.



AT625

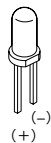

The larger metal part within the LED represents the cathode (-). Align LED for appropriate polarity and insert LED into base.

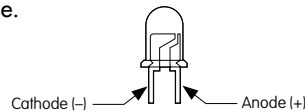

4. Align tabs (B) on both sides of actuator with the projections (A) inside of the housing and push actuator firmly down to snap in.

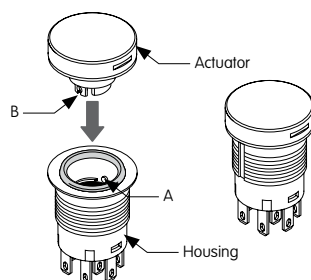

5. Install the red o-ring which was removed in step 2 at the inside bottom of the bezel.

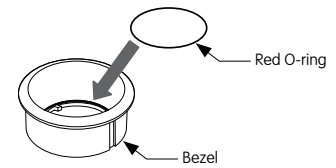

6. Align tab inside of the bezel with keyway on housing and bring bezel back into its original position.

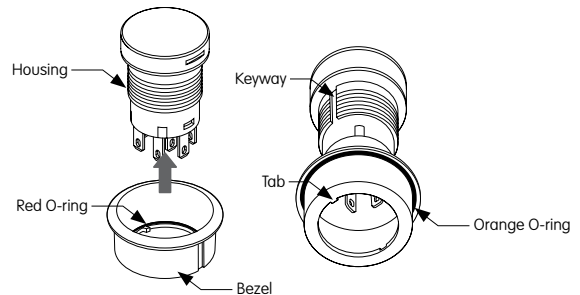

7. Before installing into panel, make sure that the orange o-ring is present at the back of the bezel. Align keyway on bezel with tab in panel and push switch all the way into the panel.

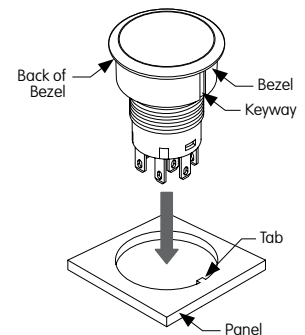

8. Attach mounting nut behind panel and tighten. Make sure that bezel and actuator fit properly and that there is no space between bezel and panel. Do not overtighten. Mounting torque: 0.785Nm (6.95 lb•in) maximum. Optional socket wrench AT106 available.

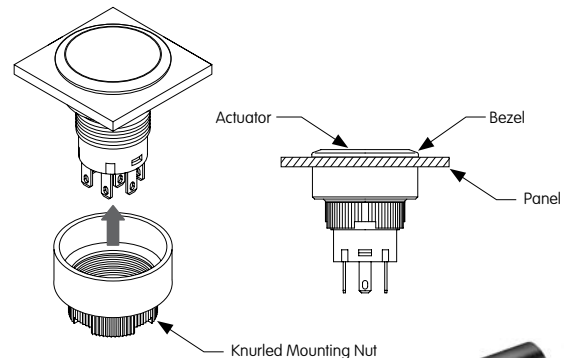

AT106 Optional Socket Wrench



LEGENDS

General information and basic specifications are presented here for customers who want to do their own legends.

Recommended Methods: Laser Etch on clear lens, Screen Print or Pad Print on lens.
Epoxy based ink is recommended.

Shaded Areas Are Printable Areas for Lens

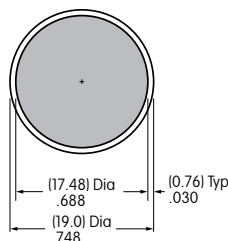

Shaded Areas Are Printable Areas for Film Insert

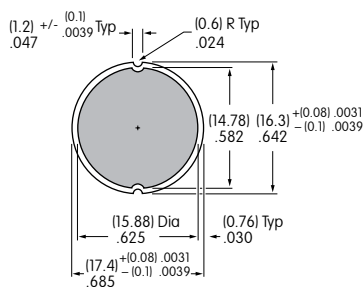

Film Material and Thickness:

Clear Polyester, 4 mil max.

Recommended Print Method:

Screen Print; Epoxy based ink is recommended.

Additional Methods

Additional methods for legends are engraving the lens and laser printing on film inserts. Maximum depth for engraving is .012" (0.3mm) on the cap lens. Enamel paint is recommended to fill the engraved area.

HANDLING & PRECAUTIONS



LEDs are electrostatic sensitive devices. When installing and handling LEDs, please use an electrostatic protected work station to prevent LED damage.



Nihon Kaiheiki Ind. Co., Ltd.
715-1, Unane, Takatsu-ku, Kawasaki-shi,
213-8553 Japan
phone: +81-44-813-8008
fax: +81-44-813-8038
www.nikkaiswitches.com
E-mail: overseas@nikkai.co.jp

